

# VIVERO 20\_VV-TYP 12-SU

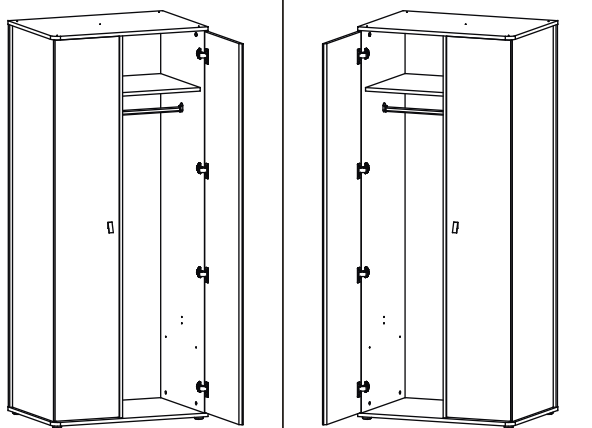

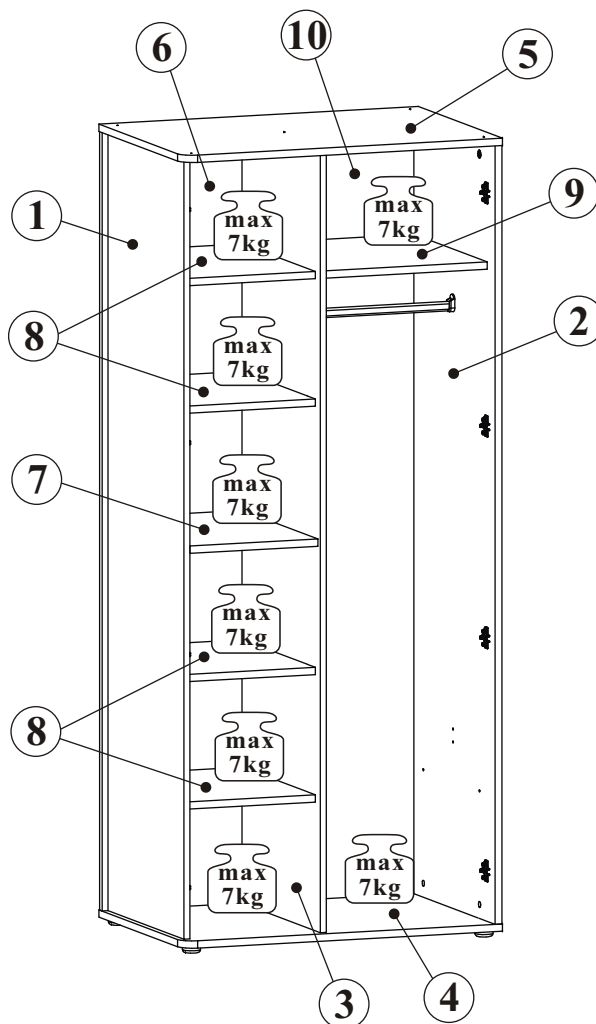

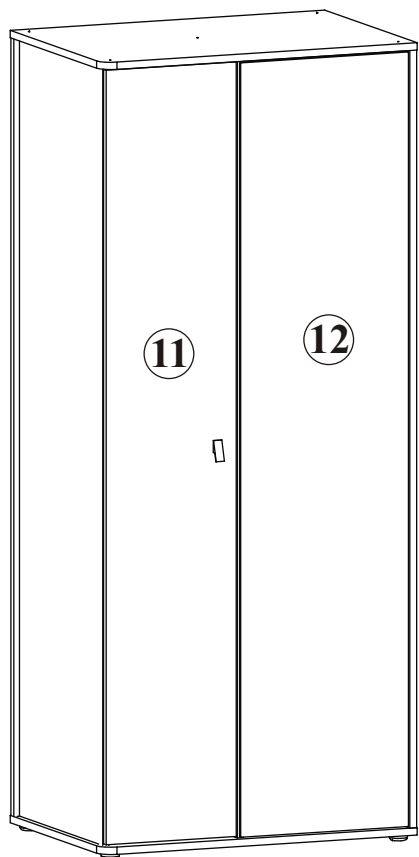

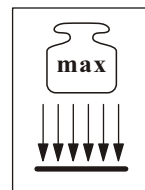
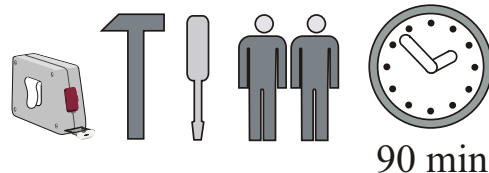



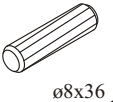
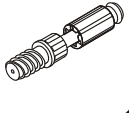

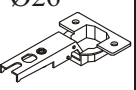
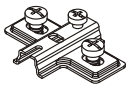
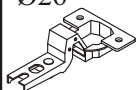
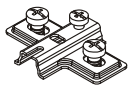

NO	Dim.			Col.-No	Qty
1	1923	518	16	2	1
2	1923	574	18	2	1
3	1923	554	16	2	1
4	836	575	18	2	1
5	836	575	18	2	1
6	1923	366	18	1	1
7	335	518	18	1	1
8	335	500	18	1	4
9	434	500	18	1	1
10	1934	445	3	1	1
11	1915	346	16	1	1
12	1915	446	18	1	1

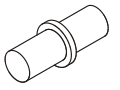

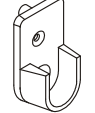
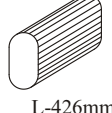

90 min

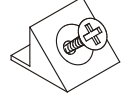
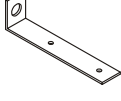
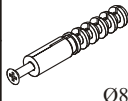
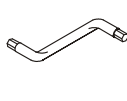
VIVERO 20\_VV-TYP 12-SU

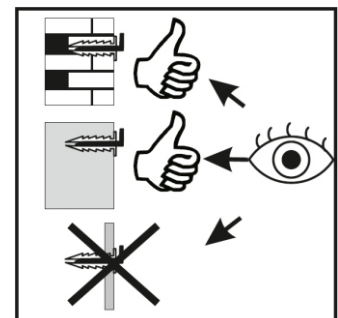
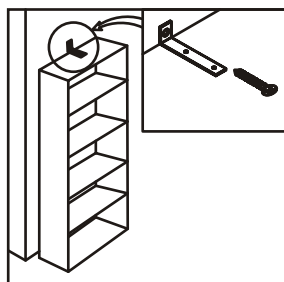
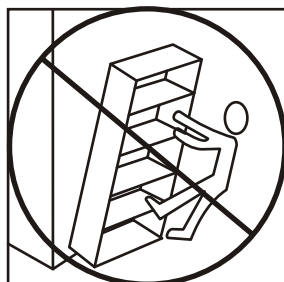
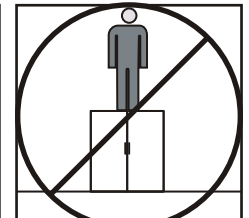
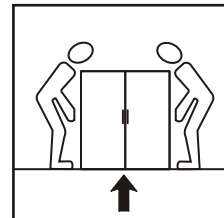
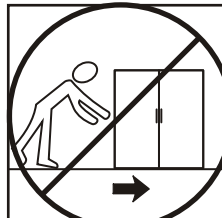
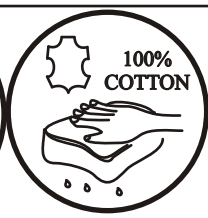
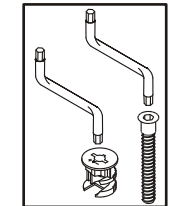
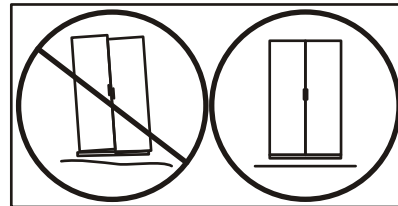
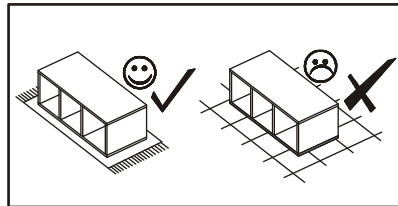
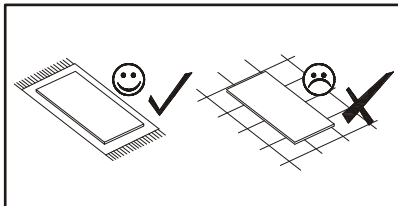
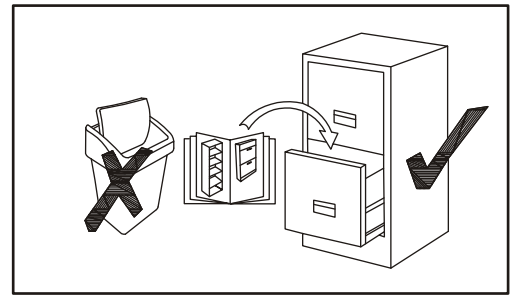
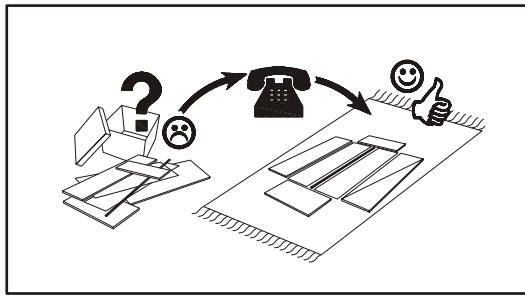
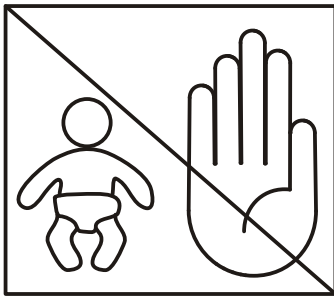
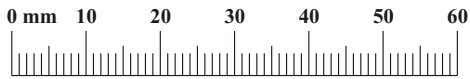
A1 x20  ø8x36	B4 x20 	B5 x20  Ø15x12	G5 x20 	B11 x2  Ø7x50	G4 x2 
E1 x4 Ø26 H=0 	E2 x4 H=0 	E5 x4 Ø26 H=16 	E4 x4 H=2 	D10 x22 USØ3,5x13 	G7 x20 
A955 x1 	DS3 x1 WSM4x20 	I11 x5 Ø45, h=15 	UP11 x5 UPØ4x20 	G10 x2 	C5 x1 L-426mm 
Z2 x8 Ø5 	S1 x18 	L1 x1 	KR1 x1 Ø8 	G2 x1 	

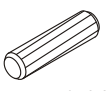
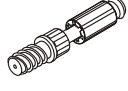

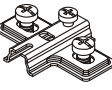
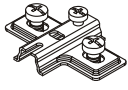
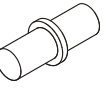
A1		B4		B5	
x8	ø8x36	x2		x8	Ø15x12
E2		E4		G7	
x4	H=0	x4	H=2	x8	

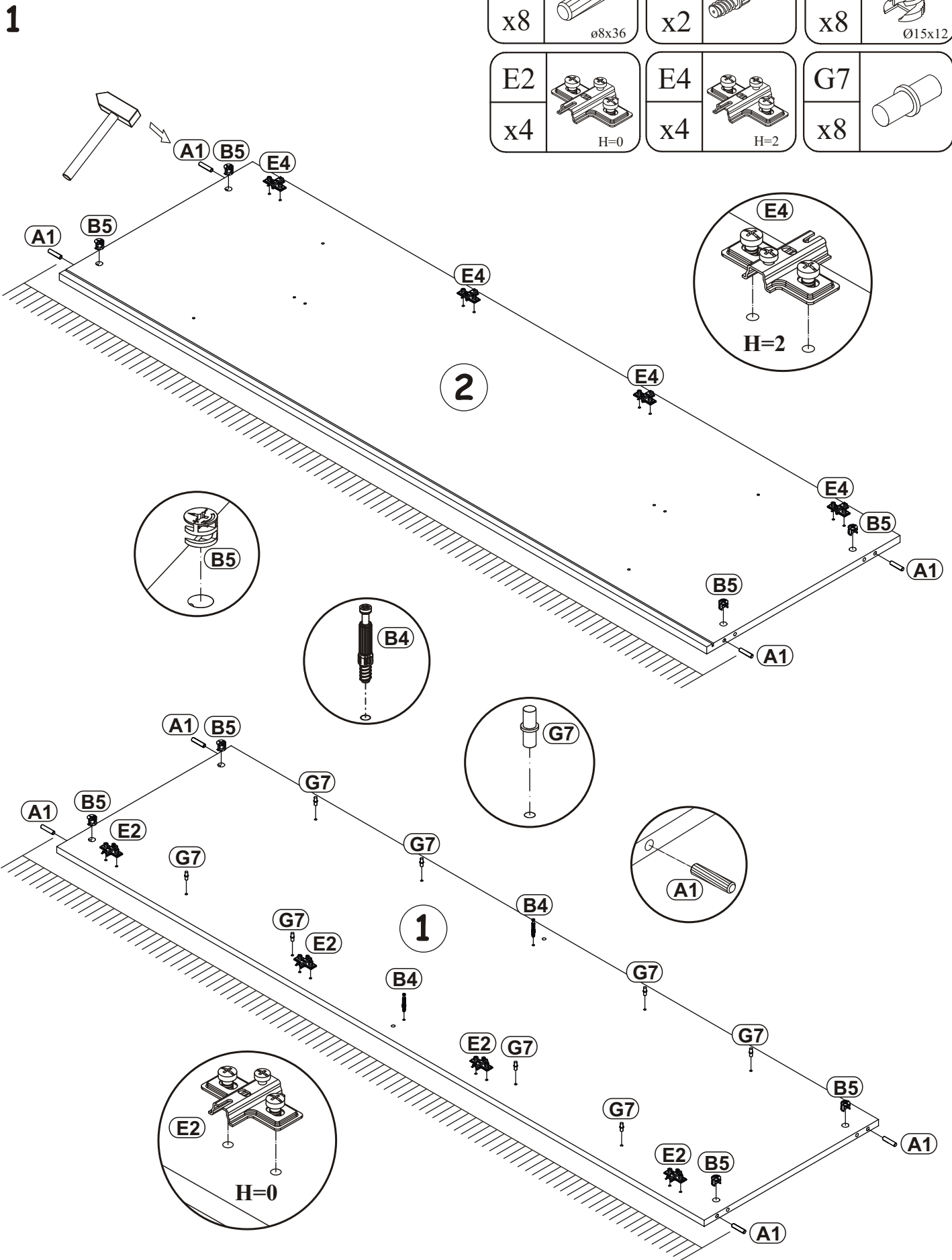

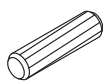

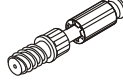
A1	
x4	∅8x36

B4	
x2	

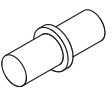
B5	
x4	∅15x12

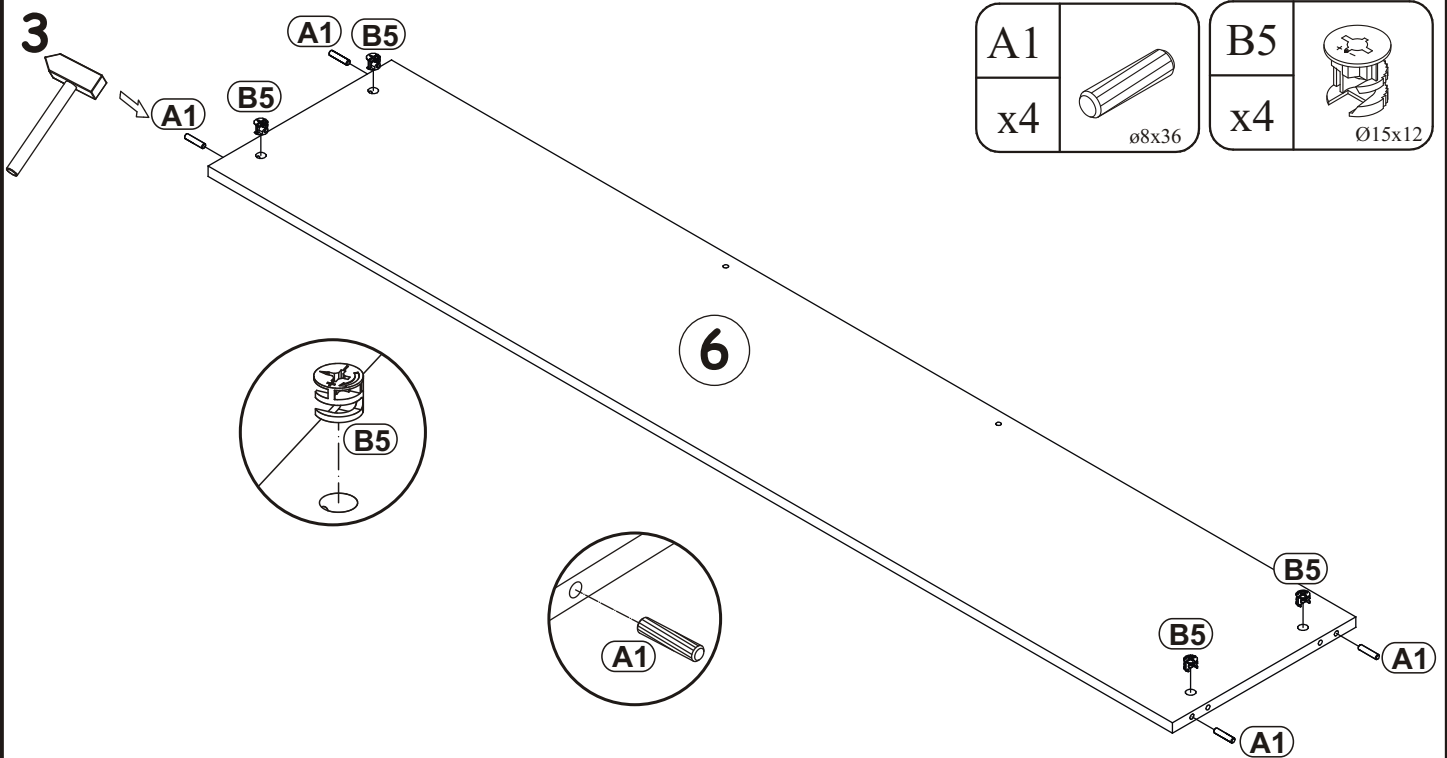
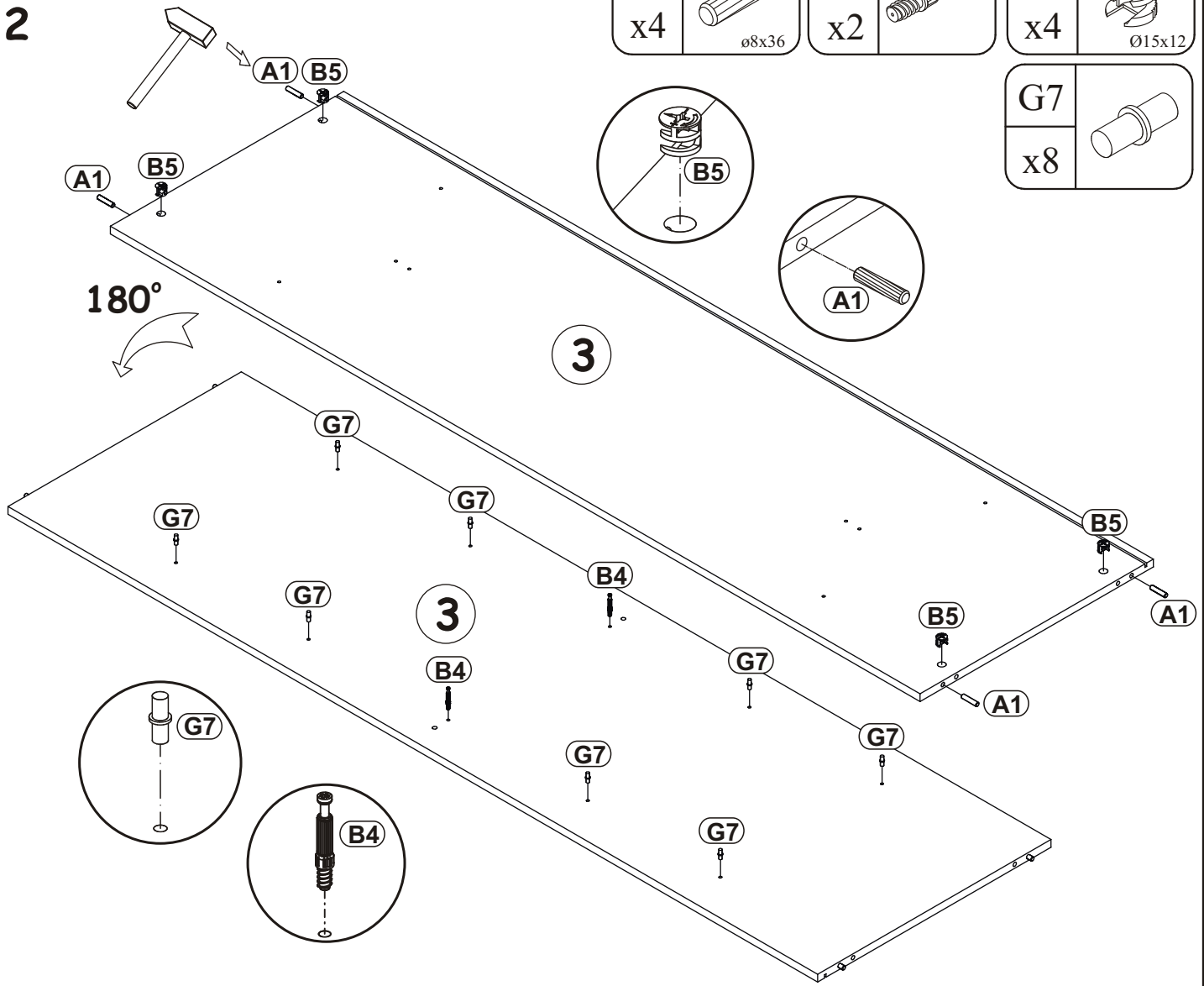
G7	
x8	



A1	
x4	∅8x36

B5	
x4	∅15x12

4

B4

x16

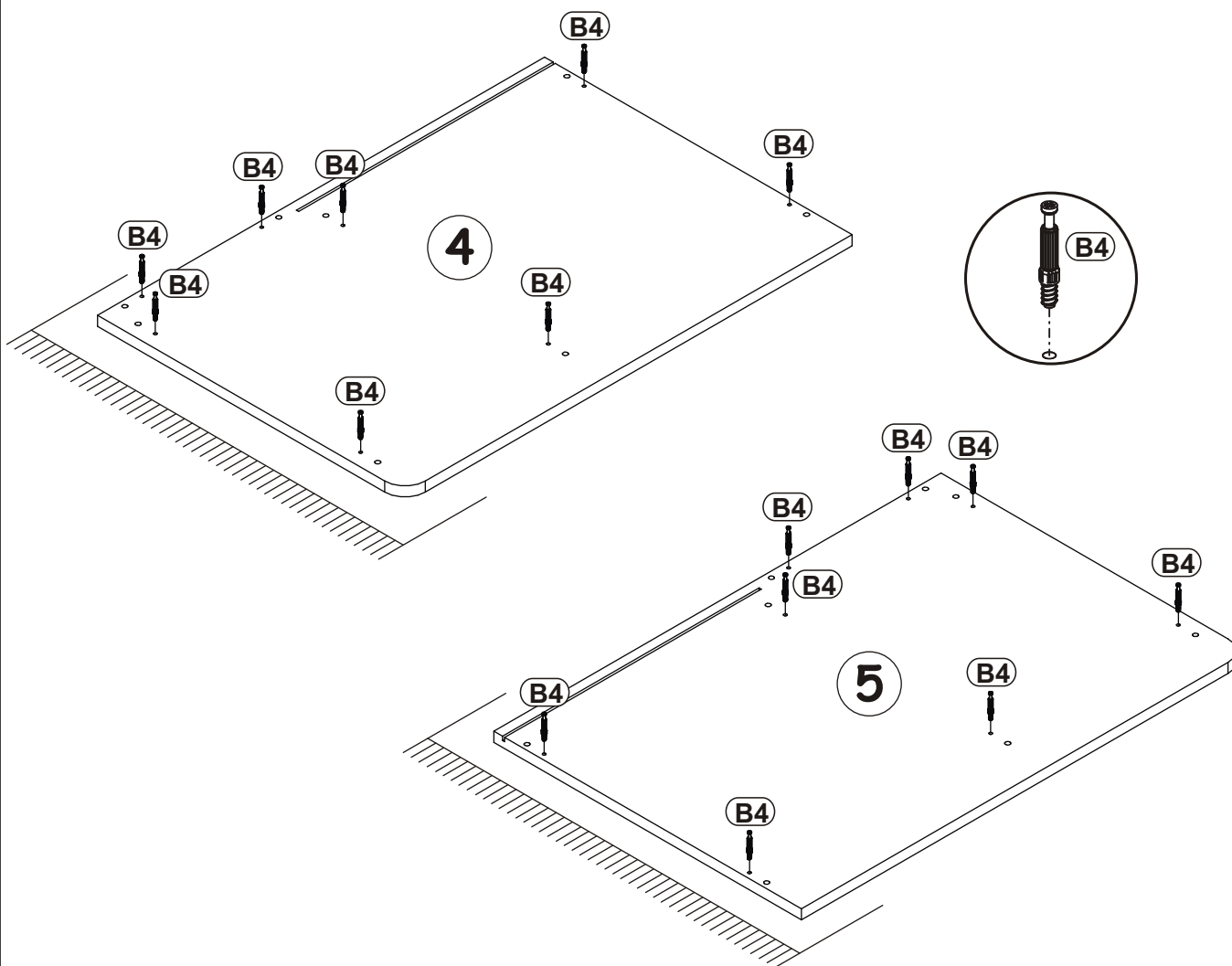
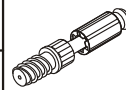

5

A1

x4

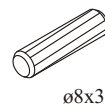

ø8x36

B5

x4



Ø15x12

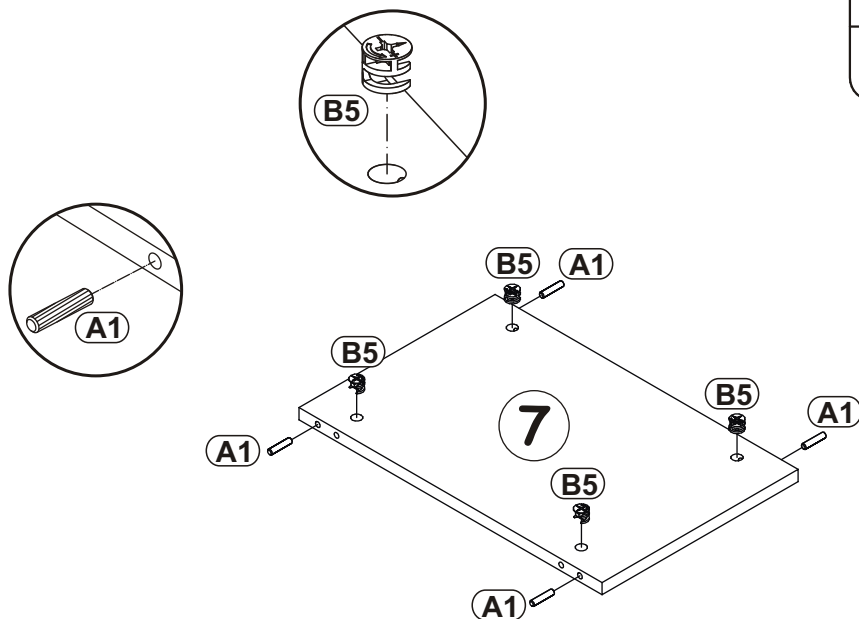

6

E1	Ø26
x4	H=0

E5	Ø26
x4	H=16

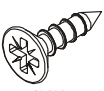
D10	
x16	USØ3,5x13

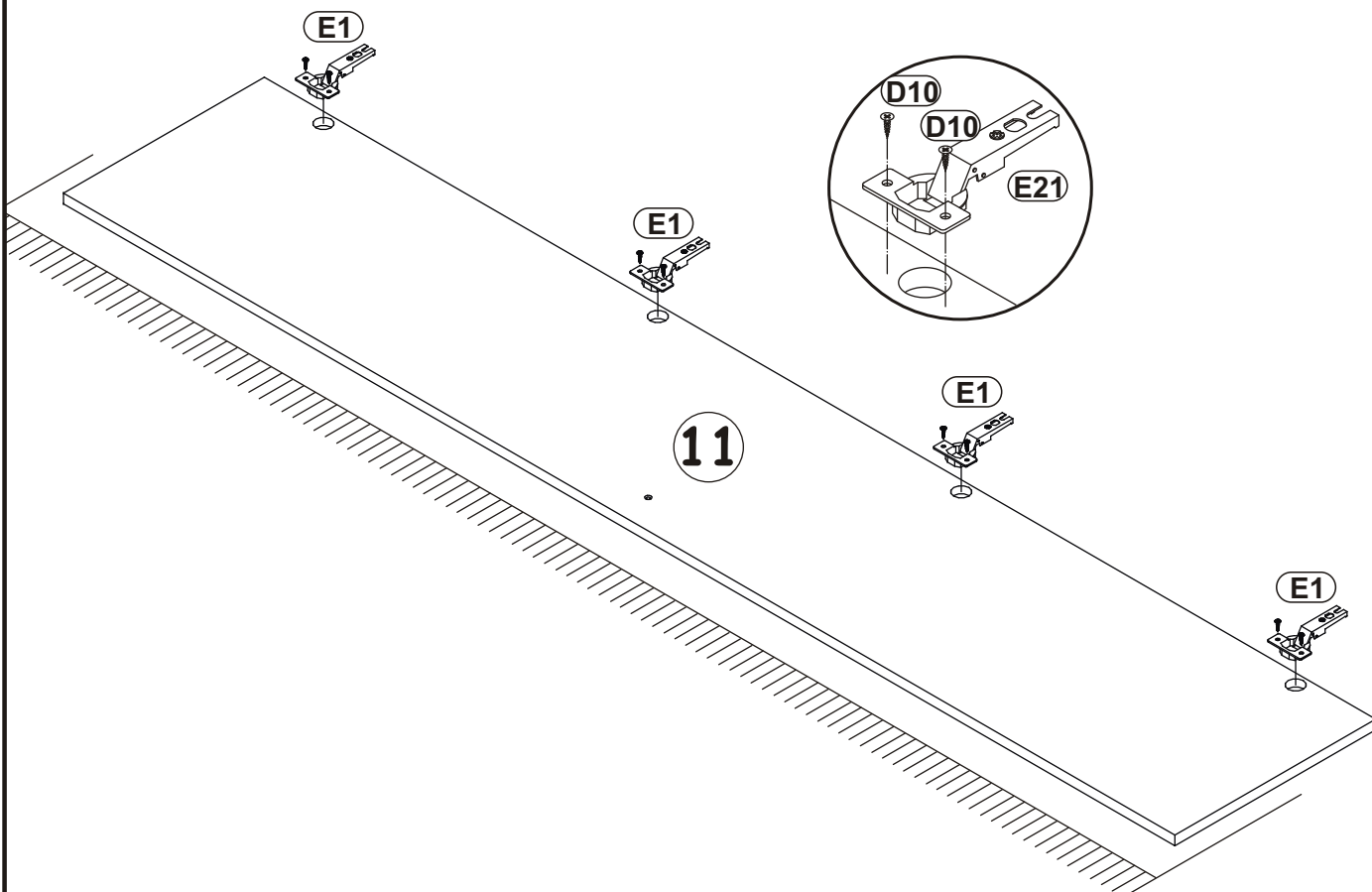
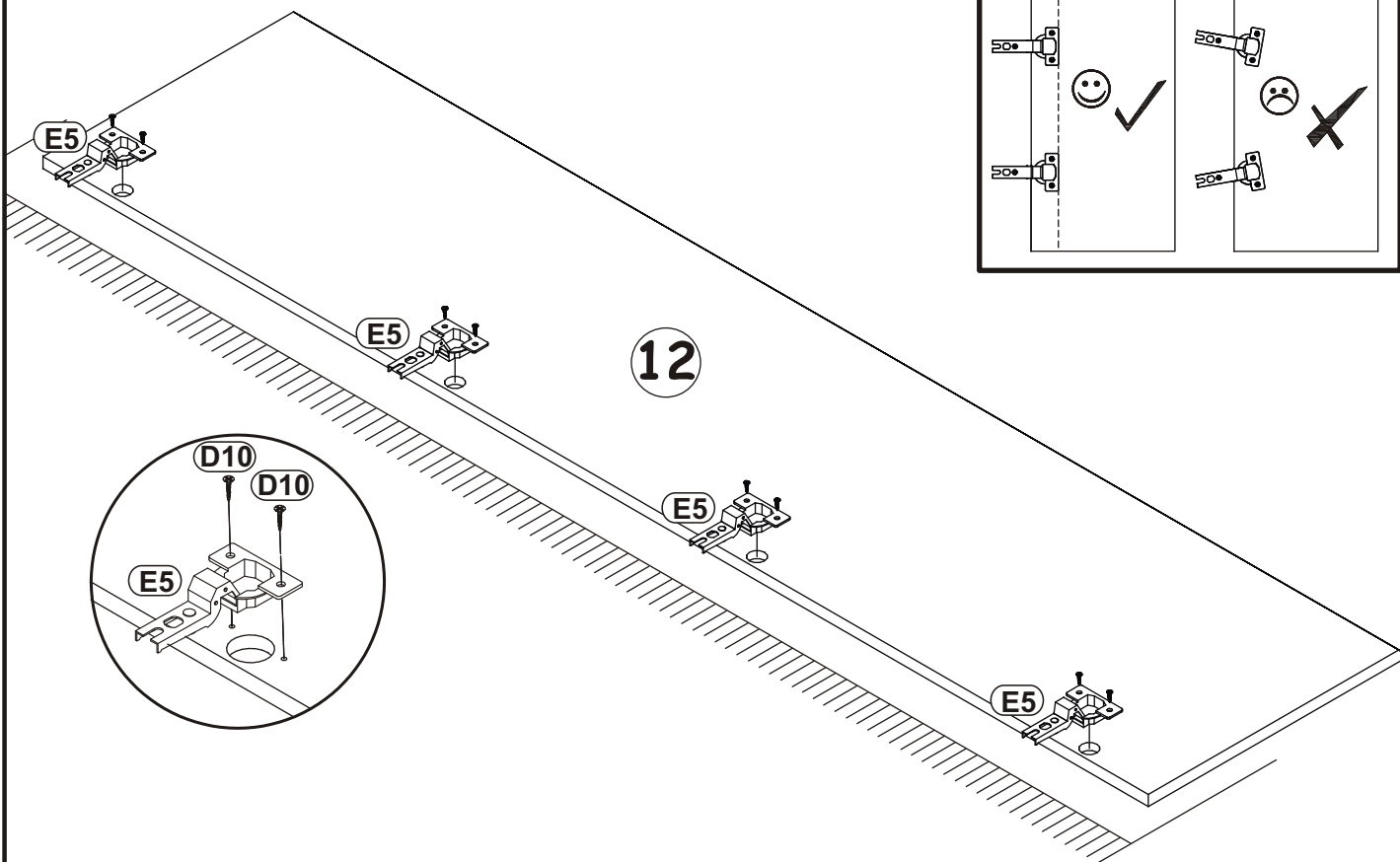
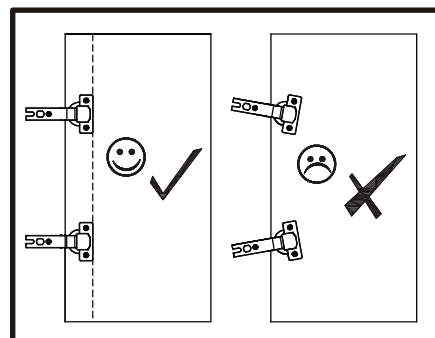

G5

x4



7

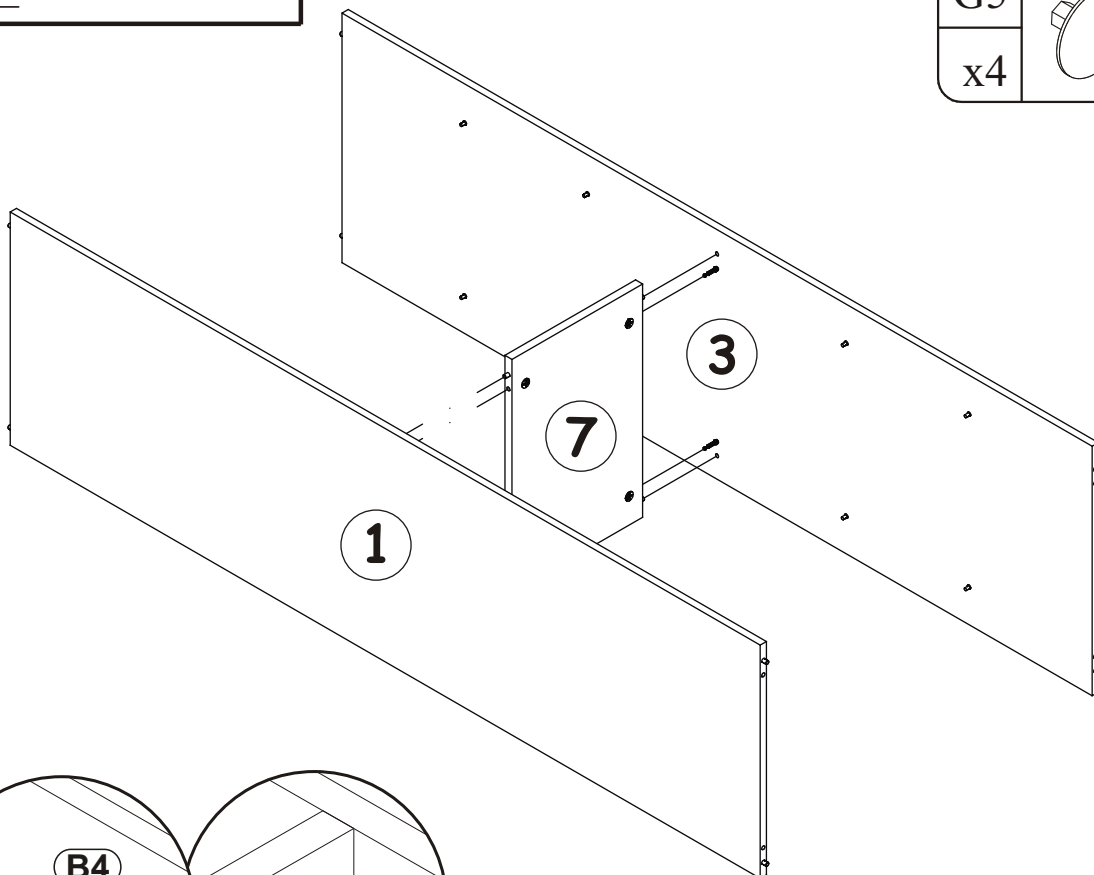

8

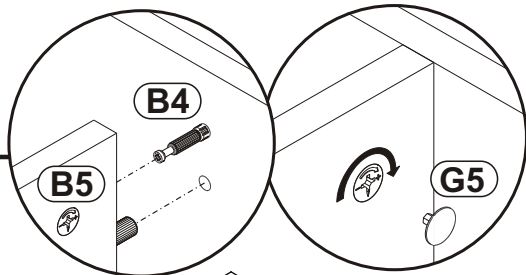

G5

x6

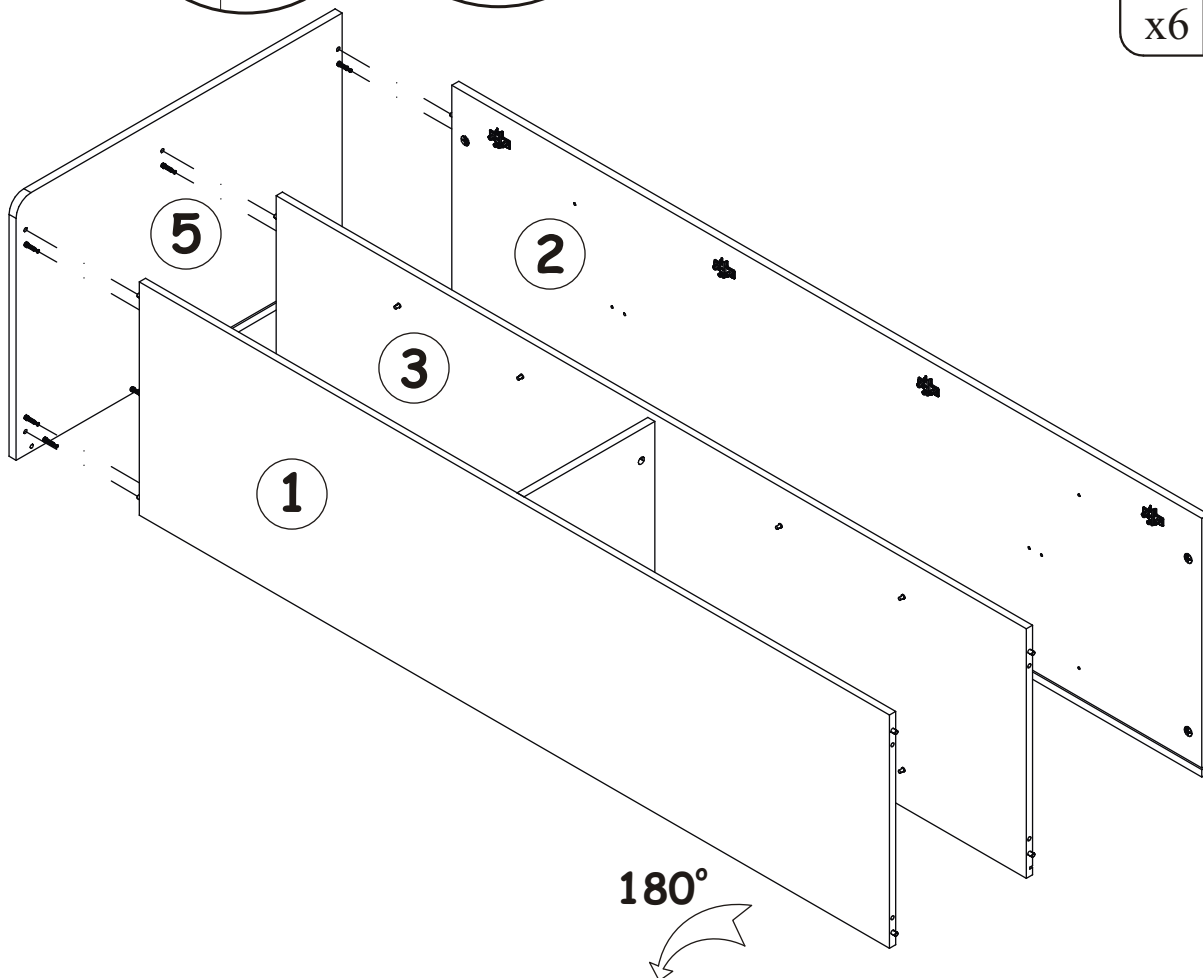

G5

x2



9

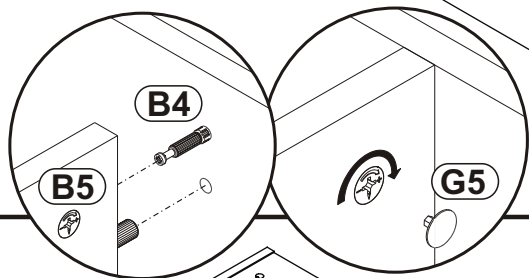
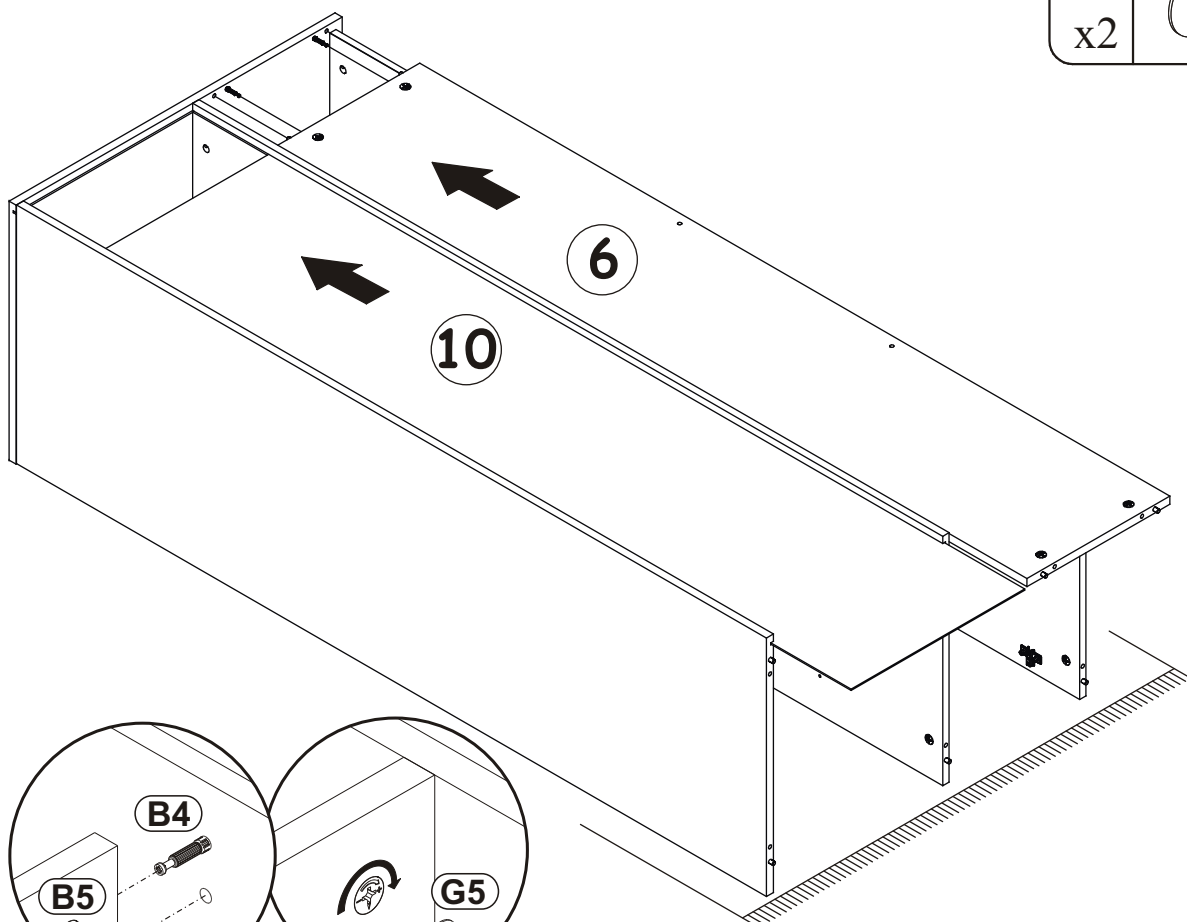

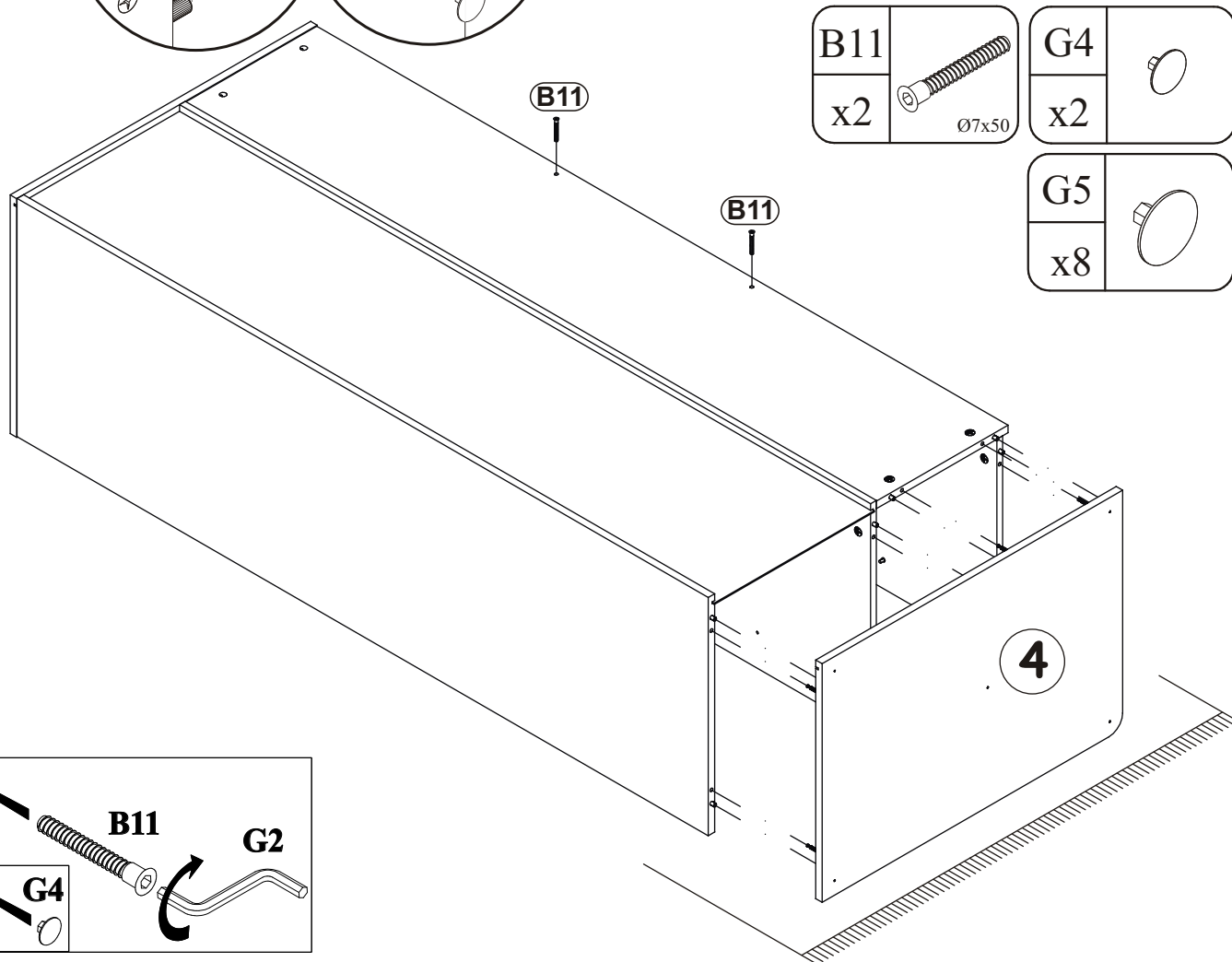

10



B11	
x2	

Ø7x50

G4	
x2	

G5	
x8	

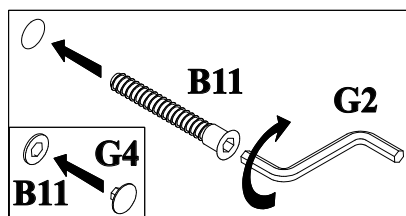





$X=Y$   $90^\circ$

S1

x18

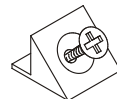

11

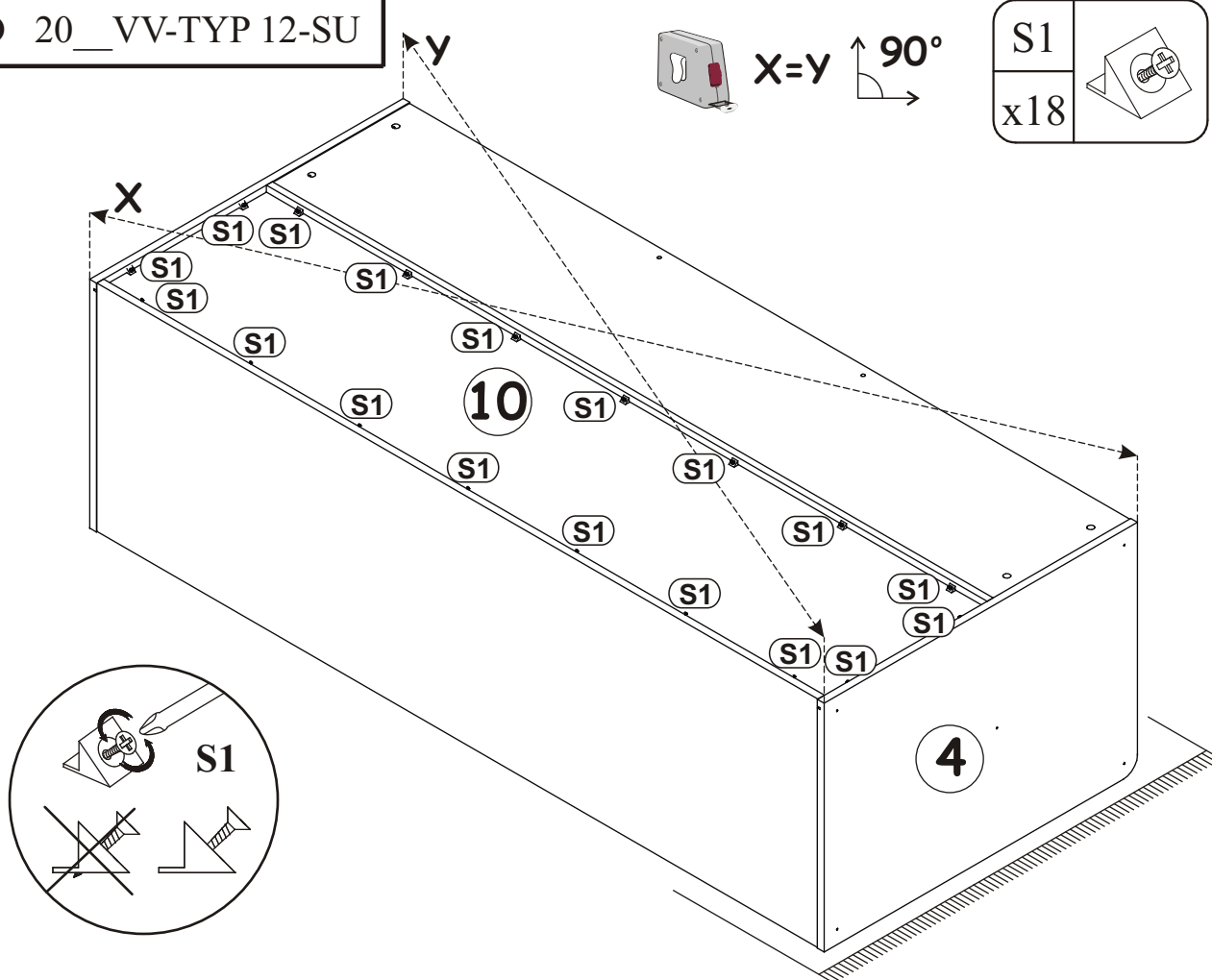

12-16

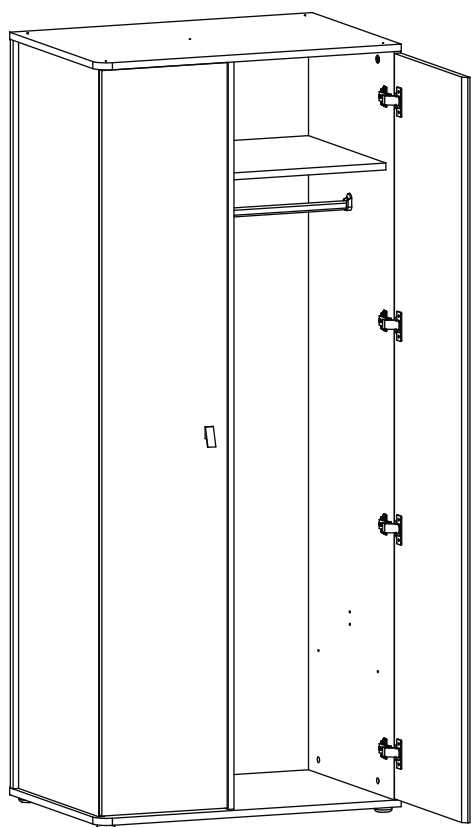

17-21

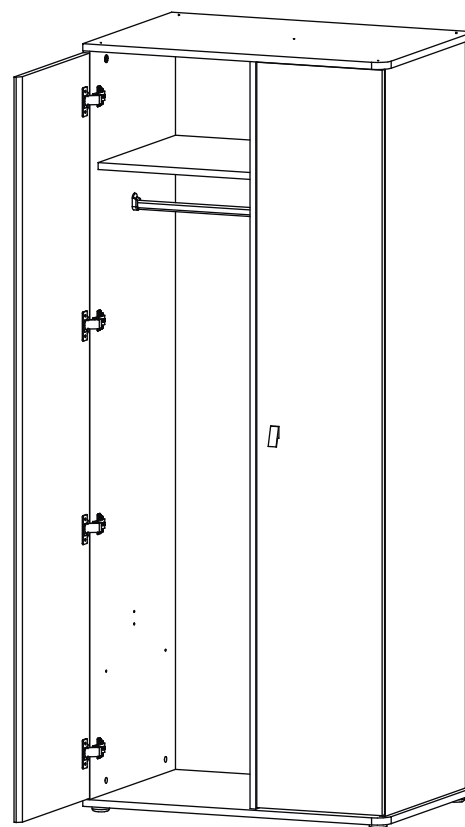

12

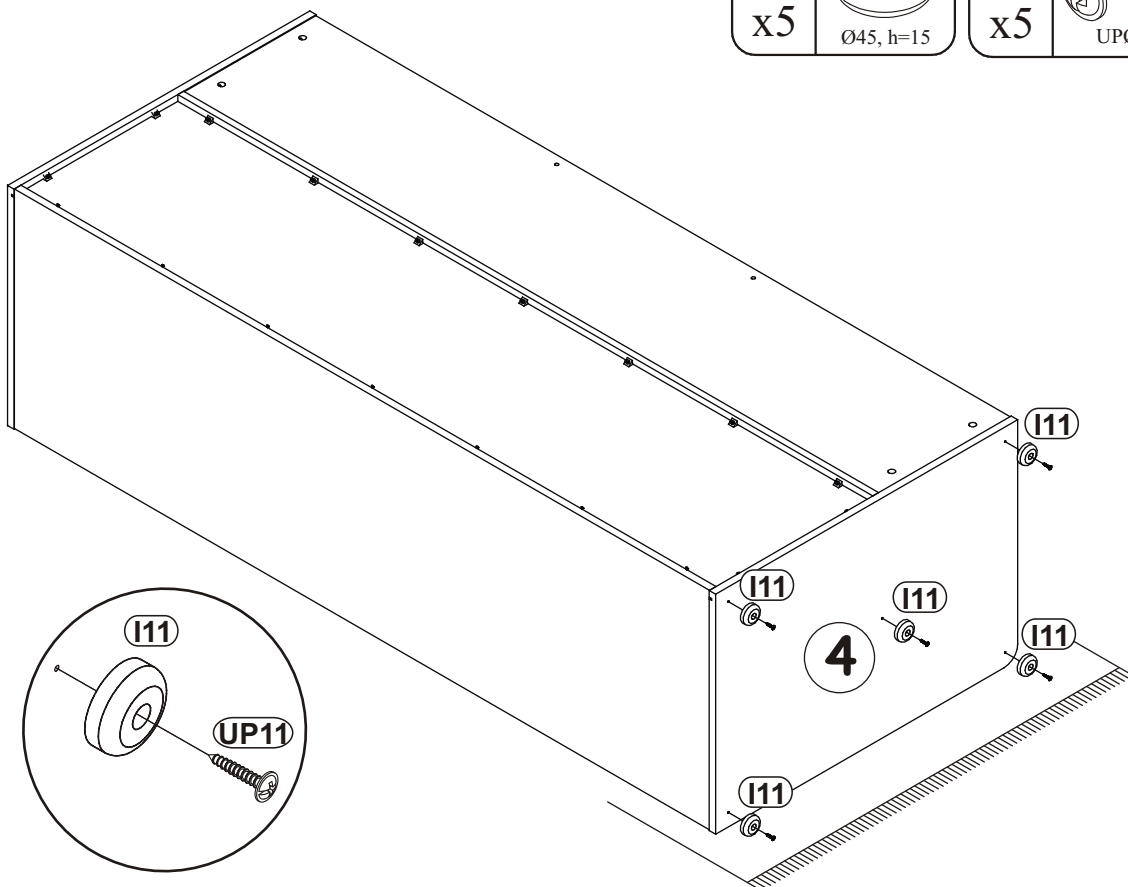
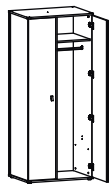

I11		UP11	
x5	Ø45, h=15	x5	UPØ4x20

13

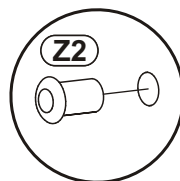
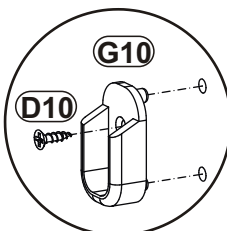
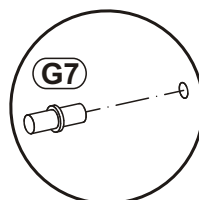
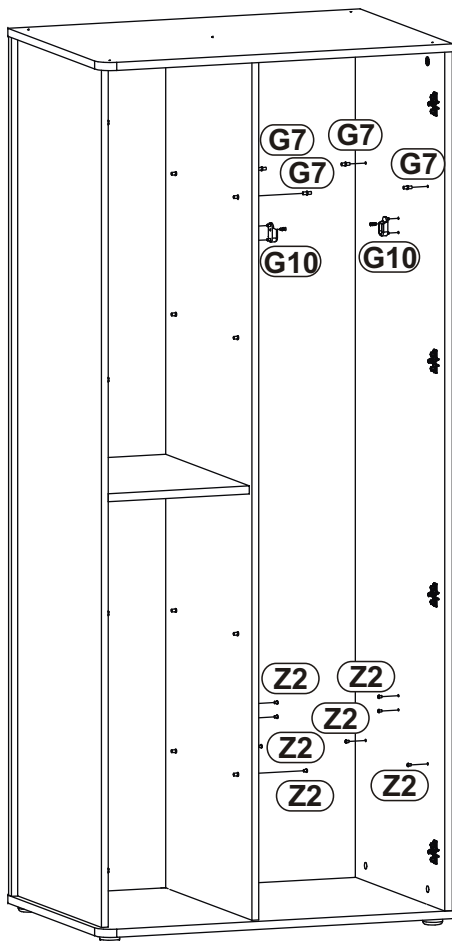

G10		D10	
x2		x4	USØ3,5x13
G7		Z2	
x4		x8	Ø5

14

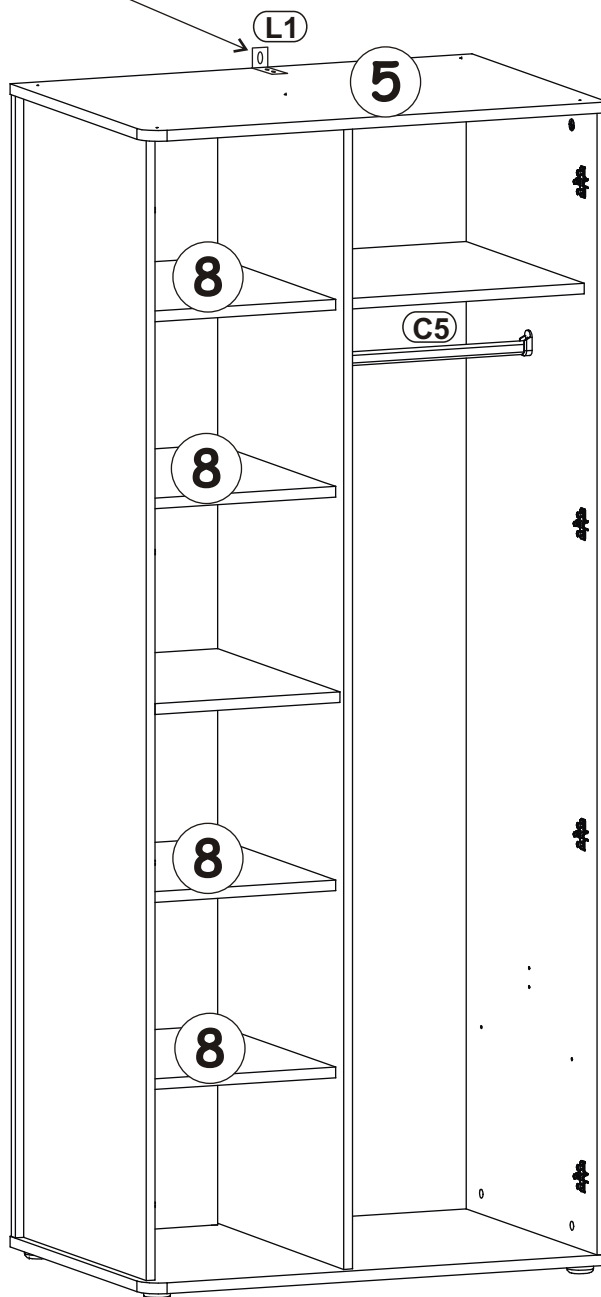
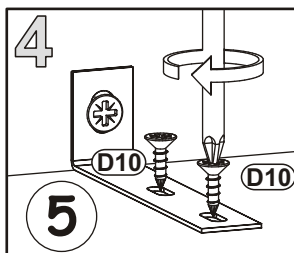
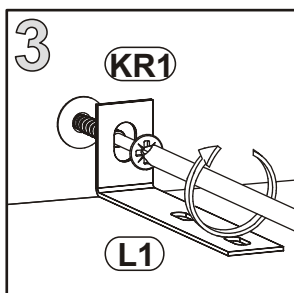
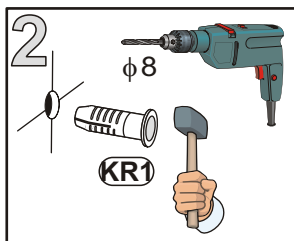
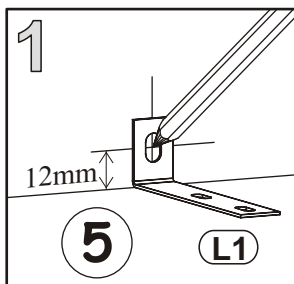
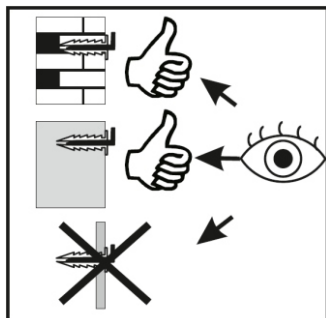
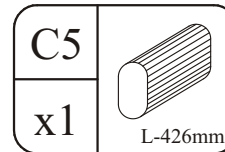
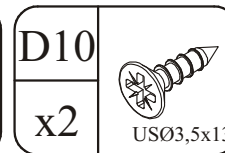
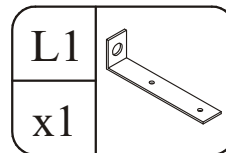
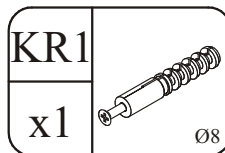
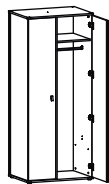

15

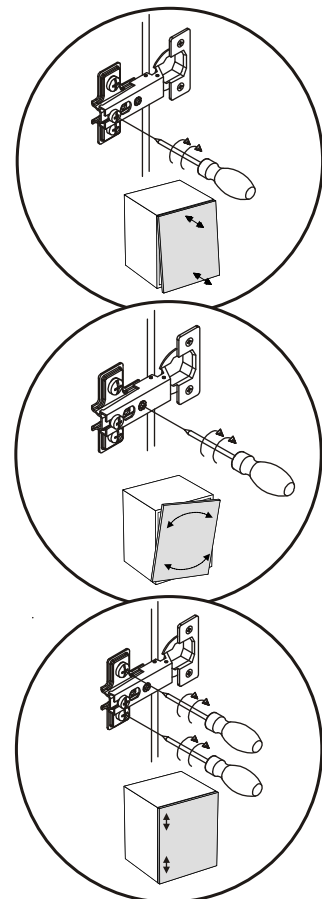
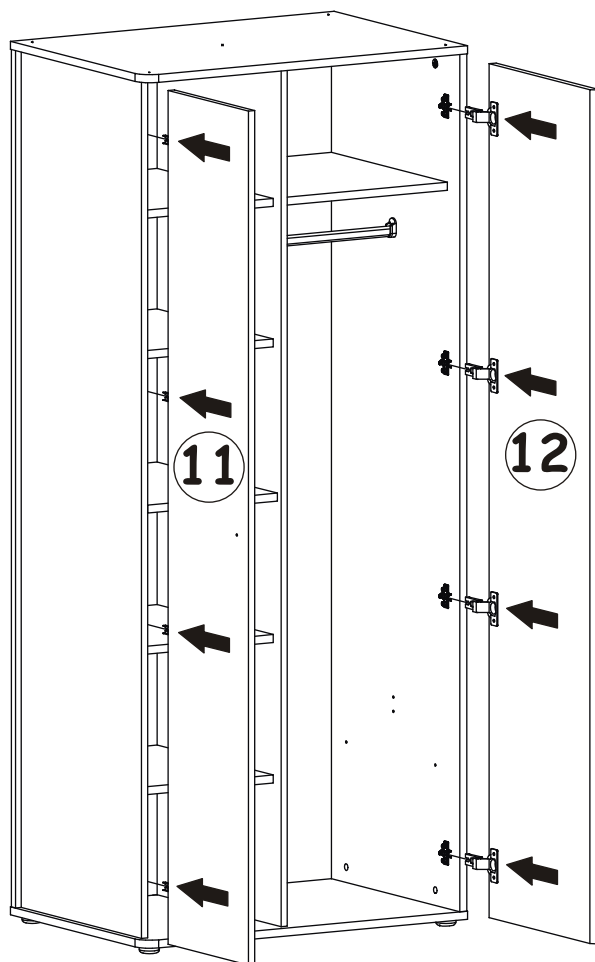
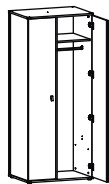

16

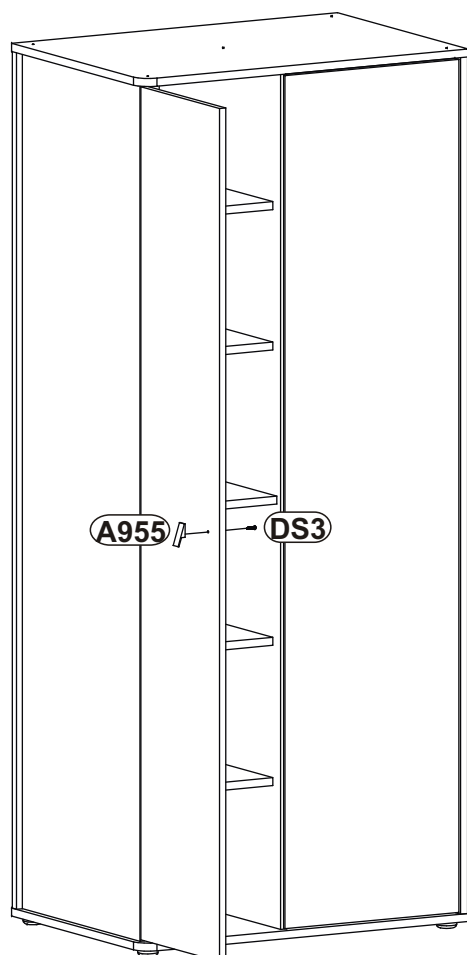



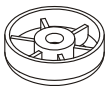
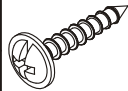

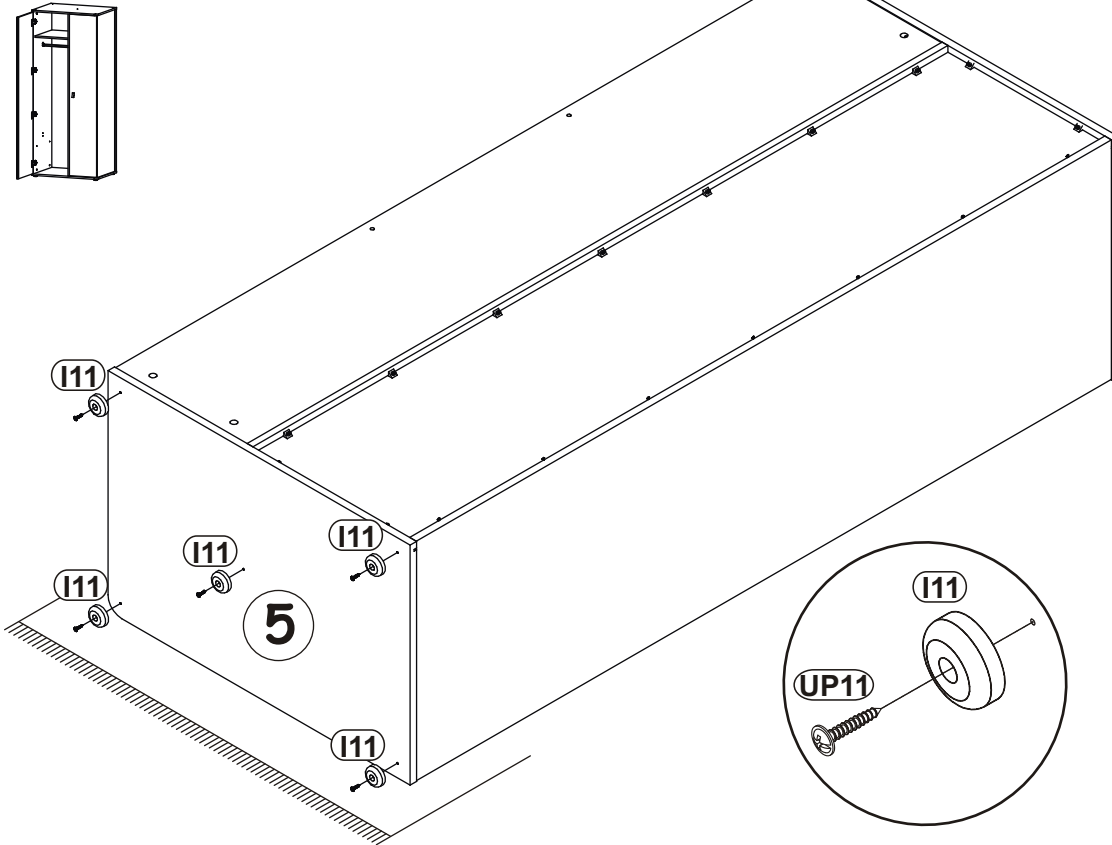
17

I11		UP11	
x5	Ø45, h=15	x5	UPØ4x20

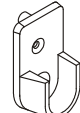

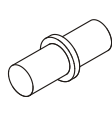
18

G10		D10	
x2		x4	USØ3,5x13
G7		Z2	
x4		x8	Ø5

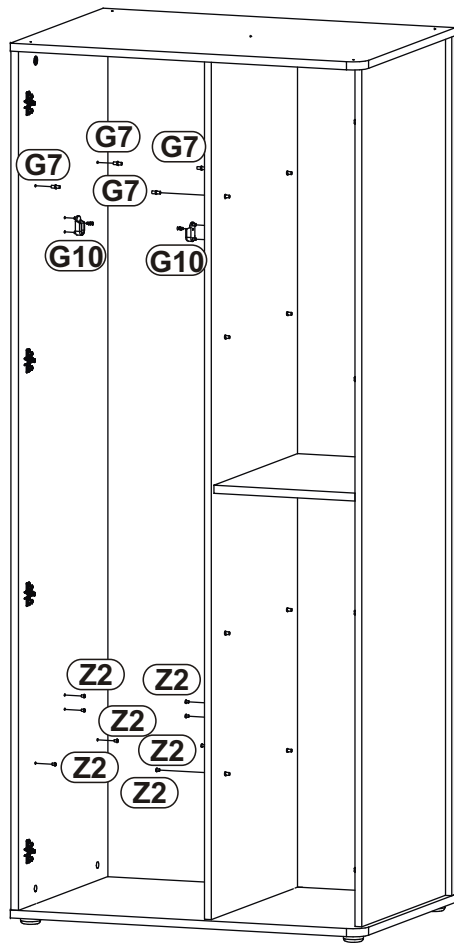
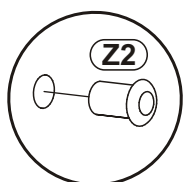
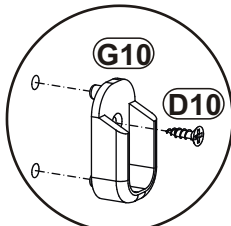
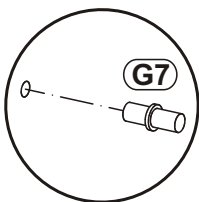

19

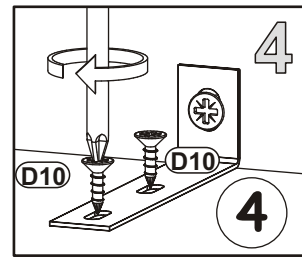
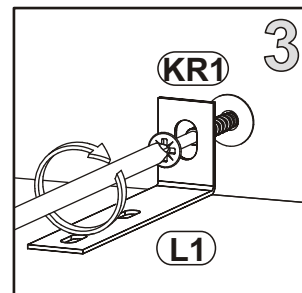
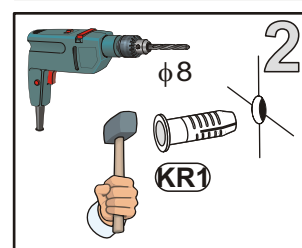
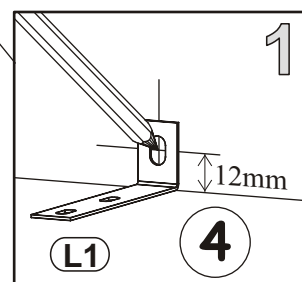
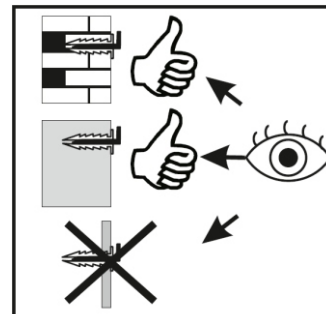
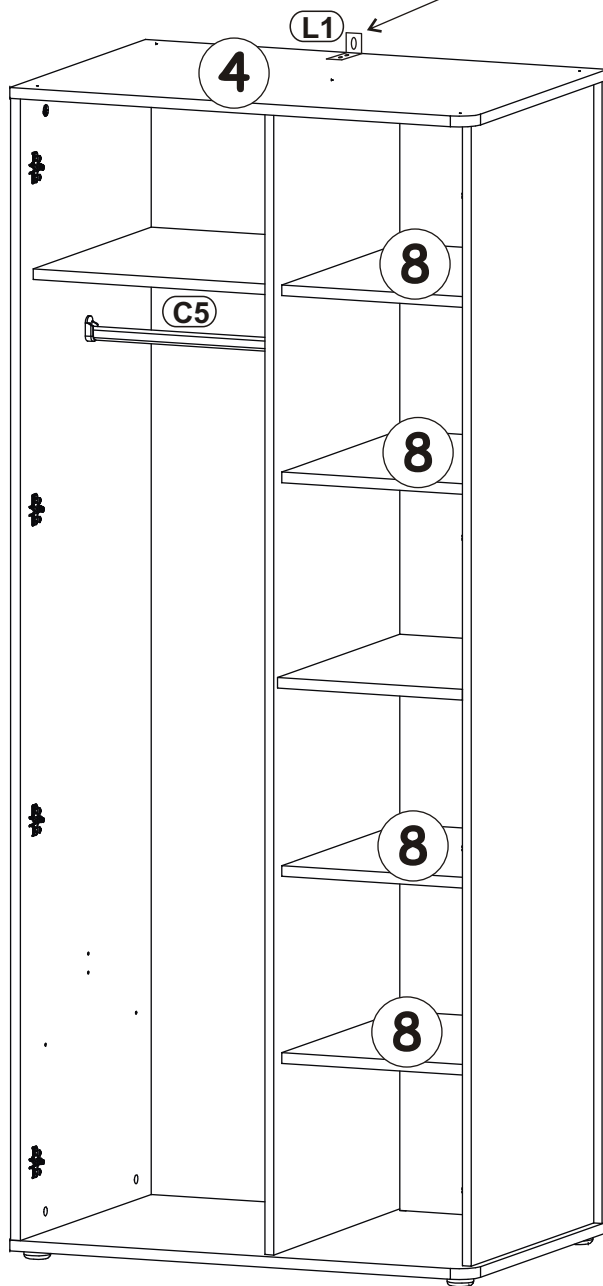
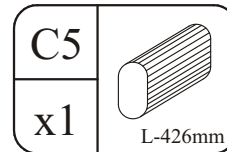
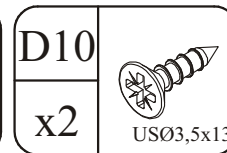
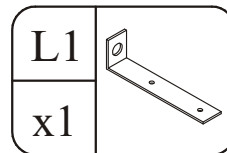
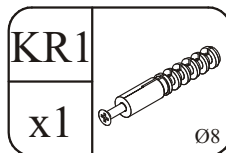
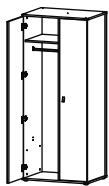

20

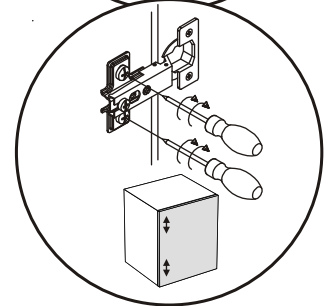
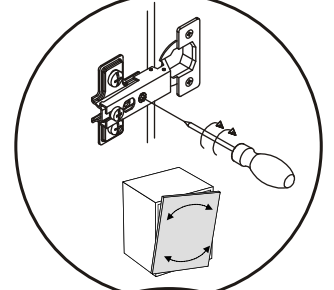
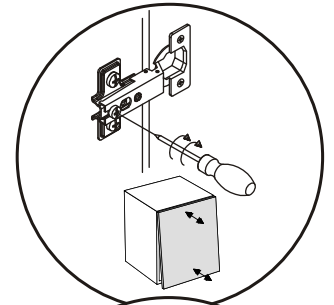
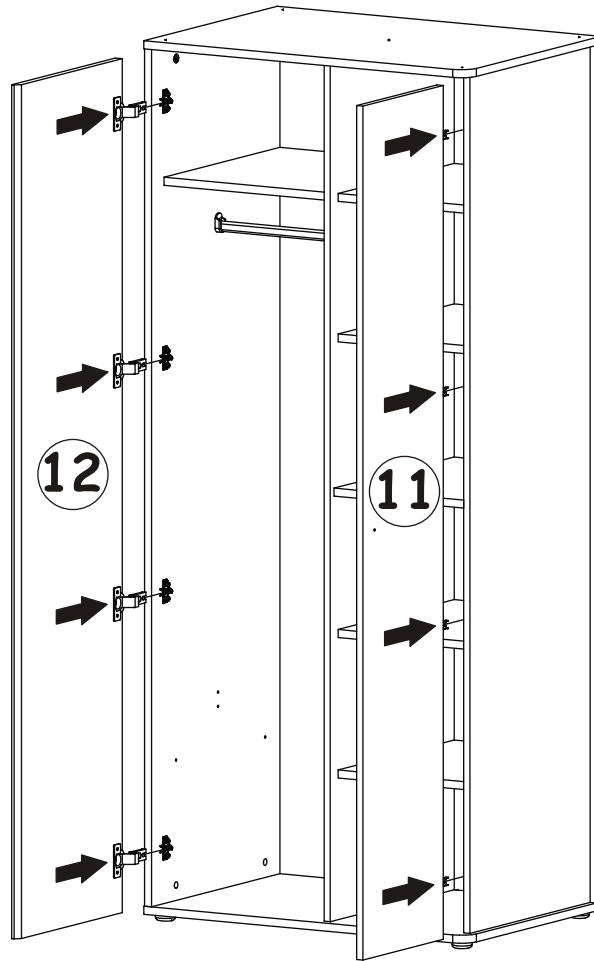
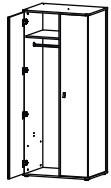

21

